

Product Description

The BSW6550 is a 50-ohm matched absorptive SP5T RF switch that provides ultra-high isolation with frequency coverage up to 9 GHz.

The BSW6550 is designed with high linearity and reliability, making it suitable for wireless communication applications such as 4G/5G/6G infrastructure.

The BSW6550 operates over a wide VDD range of 2.7V to 5.5V and is controlled via 3 logic pins. Additionally, the BSW6550 has a bypass mode function that can disable the internal negative voltage, and an external negative Vss can be supplied through pin 20.

The BSW6550 is designed with ESD protection circuits at all pins and packaged in an industry standard, fully RoHS2-compliant, 24-Lead, 4mm x 4mm x 0.75mm QFN thin package.

The BSW6550 does not require blocking capacitors. If DC is presented at the RF port, add a blocking capacitor.

Block Diagram

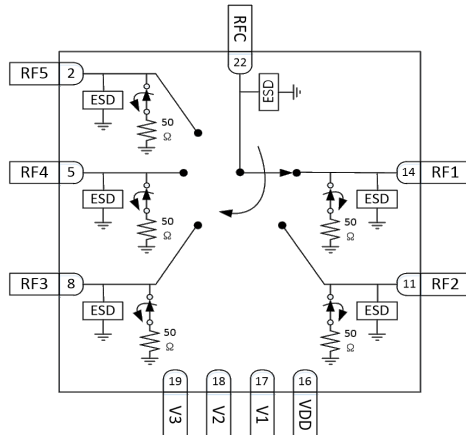

Figure 1. Functional Block Diagram

Applications

- Wireless Communication such as 4G/5G/6G
- Massive MIMO active Antenna Systems
- Repeaters
- Digital Pre-Distortion
- Military Systems
- UWB
- Test & Measurement

Package Type



4mm x 4mm x 0.75mm, 24-Lead QFN Package

Figure 2. Package Type

Device Features

- Output frequency range : 5 MHz to 9.0 GHz
- Supply Voltage : 2.7V to 5.5V
- Low Insertion Loss
 - : 0.67dB @ 2GHz
 - : 0.90dB @ 4GHz
 - : 1.01dB @ 6GHz
- High Isolation
 - RFC to RFx
 - : 70dB @ 2GHz
 - : 59dB @ 4GHz
 - : 50dB @ 6GHz
 - RFx to RFx
 - : 61dB @ 2GHz
 - : 56dB @ 4GHz
 - : 54dB @ 6GHz
- High Input 1dB Compression
 - : 35.1dBm @ 2.35GHz
 - : 35.4dBm @ 3.5GHz
 - : 35.7dBm @ 5.75GHz
- High IIP3
 - : 64dBm @ 2.35GHz
 - : 63dBm @ 3.5GHz
 - : 63dBm @ 5.75GHz
- Fast Switching Time : 180ns
- Operating temperature range : -40°C to +125°C
- ESD, HBM : 1.0kV
- Optional External Negative Supply (Bypass Mode)
- 24-Lead QFN package : 4.0mm x 4.0mm x 0.75mm
- Lead-free/RoHS2-compliant QFN SMT package

Electrical Specifications

Typical conditions are Normal Mode¹(VDD = 5V, VSSEXT= 0V) or Bypass Mode²(VDD = 5V, VSSEXT = -3.5V), T_A = 25°C, Control Logic V1/V2/V3 Low = 0V, V1/V2/V3 High = 3.3V, Z_L = 50Ω, PCB and RF Connector loss are de-embedded, unless otherwise noted.

Table 1. Electrical Specifications

| Parameter | Path | Conditions | Min | Typ | Max | Unit |
|---------------------|-----------|------------|------|------|------|------|
| Operating Frequency | | | 5 | | 9000 | MHz |
| Insertion Loss | RFC - RF1 | 1GHz | | 0.59 | | dB |
| | | 2GHz | | 0.67 | | |
| | | 3GHz | | 0.82 | | |
| | | 4GHz | | 0.90 | | |
| | | 5GHz | | 0.91 | | |
| | | 6GHz | | 1.01 | | |
| | | 7GHz | | 1.44 | | |
| | | 8GHz | | 2.22 | | |
| | | 9GHz | | 2.42 | | |
| | RFC - RF2 | 1GHz | | 0.56 | | dB |
| | | 2GHz | | 0.65 | | |
| | | 3GHz | | 0.78 | | |
| | | 4GHz | | 0.83 | | |
| | | 5GHz | | 0.88 | | |
| | | 6GHz | | 0.99 | | |
| | | 7GHz | | 1.35 | | |
| | | 8GHz | | 2.13 | | |
| | | 9GHz | | 2.43 | | |
| | RFC - RF3 | 1GHz | | 0.56 | | dB |
| | | 2GHz | | 0.65 | | |
| 3GHz | | | 0.78 | | | |
| 4GHz | | | 0.84 | | | |
| 5GHz | | | 0.87 | | | |
| 6GHz | | | 0.99 | | | |
| 7GHz | | | 1.36 | | | |
| 8GHz | | | 2.21 | | | |
| 9GHz | | | 2.53 | | | |
| RFC - RF4 | 1GHz | | 0.55 | | dB | |
| | 2GHz | | 0.64 | | | |
| | 3GHz | | 0.77 | | | |
| | 4GHz | | 0.82 | | | |
| | 5GHz | | 0.86 | | | |
| | 6GHz | | 0.94 | | | |
| | 7GHz | | 1.28 | | | |
| | 8GHz | | 2.06 | | | |
| | 9GHz | | 2.27 | | | |
| RFC - RF5 | 1GHz | | 0.58 | | dB | |
| | 2GHz | | 0.67 | | | |
| | 3GHz | | 0.79 | | | |
| | 4GHz | | 0.85 | | | |
| | 5GHz | | 0.87 | | | |
| | 6GHz | | 0.96 | | | |
| | 7GHz | | 1.25 | | | |
| | 8GHz | | 1.93 | | | |
| | 9GHz | | 2.24 | | | |

1. Normal Mode : Single external positive supply voltage(VDD) inputted.

2. Bypass Mode : Both external positive supply voltage(VDD) and external negative voltage(VSSEXT) inputted.

Table 1. Electrical Specifications (Cont.)

| Parameter | Path | Conditions | Min | Typ | Max | Unit |
|---------------------------------------|-----------|---|-----|----------------------|-----|----------|
| Return Loss (Active port) | RFC, RFx | 5MHz - 6GHz 6GHz - 9GHz | | 15 8 | | dB |
| Return Loss (Terminated port) | RFC, RFx | 5MHz - 9GHz | | 15 | | dB |
| Input P1dB | RFC - RFx | 2.35GHz 3.5GHz 5.75GHz | | 35.1 35.4 35.7 | | dBm |
| Input IP2 ³ | RFC - RFx | 2.35GHz 3.5GHz 5.75GHz | | 110 112 107 | | dBm |
| Input IP3 ³ | RFC - RFx | 2.35GHz 3.5GHz 5.75GHz | | 64 63 63 | | dBm |
| 2 nd Harmonic ⁴ | RFC - RFx | 2.35GHz 3.5GHz 5.75GHz | | 97 100 95 | | dBc |
| 3 rd Harmonic ⁴ | RFC - RFx | 2.35GHz 3.5GHz 5.75GHz | | 101 97 100 | | dBc |
| Rising Time Falling Time | RFC - RFx | 10% RF to 90% RF 90% RF to 10% RF | | 40 40 | | ns |
| Switching Time | RFC - RFx | 50% CTRL to 90% RF 50% CTRL to 10% RF | | 180 100 | | ns |
| Settling Time | RFC - RFx | 50% CTRL to 0.05dB final value Rising Edge 50% CTRL to 0.05dB final value Falling Edge | | 190 105 | | ns |
| Maximum Spurious Level | | 1MHz - 10MHz > 10MHz ⁵ | | -127 < -140 | | dBm/10Hz |

3. The each-tone Power is +18dBm and Tone spacing is 20kHz.

4. Tone Power is +18dBm.

5. No spurious signals were detected above 10MHz.

Isolation Matrix

Typical conditions are Normal Mode¹(VDD = 5V, VSSEXT= 0V) or Bypass Mode²(VDD = 5V, VSSEXT = -3.5V), T_A = 25°C, Control Logic V1/V2/V3 Low = 0V, V1/V2/V3 High = 3.3V, Z_L = 50Ω, unless otherwise noted.

Table 2. RFC-to-RFx Isolation

| "ON" Port | Frequency | RFC to RFX Isolation | | | | | Unit |
|-----------|-----------|----------------------|-----|-----|-----|-----|------|
| | | RF1 | RF2 | RF3 | RF4 | RF5 | |
| RF1 | 1GHz | - | 80 | 74 | 85 | 84 | dB |
| | 2GHz | - | 70 | 68 | 77 | 72 | |
| | 3GHz | - | 64 | 66 | 70 | 65 | |
| | 4GHz | - | 59 | 65 | 63 | 58 | |
| | 5GHz | - | 54 | 65 | 57 | 52 | |
| | 6GHz | - | 50 | 58 | 51 | 48 | |
| | 7GHz | - | 47 | 52 | 47 | 43 | |
| | 8GHz | - | 44 | 48 | 43 | 39 | |
| | 9GHz | - | 40 | 42 | 39 | 36 | |
| RF2 | 1GHz | 87 | - | 69 | 88 | 81 | dB |
| | 2GHz | 80 | - | 64 | 76 | 71 | |
| | 3GHz | 70 | - | 61 | 68 | 64 | |
| | 4GHz | 62 | - | 61 | 62 | 57 | |
| | 5GHz | 56 | - | 64 | 56 | 52 | |
| | 6GHz | 51 | - | 69 | 51 | 47 | |
| | 7GHz | 46 | - | 57 | 47 | 43 | |
| | 8GHz | 43 | - | 49 | 43 | 39 | |
| | 9GHz | 39 | - | 43 | 39 | 36 | |
| RF3 | 1GHz | 86 | 69 | - | 84 | 79 | dB |
| | 2GHz | 77 | 64 | - | 77 | 70 | |
| | 3GHz | 69 | 61 | - | 69 | 63 | |
| | 4GHz | 62 | 60 | - | 63 | 57 | |
| | 5GHz | 57 | 63 | - | 56 | 51 | |
| | 6GHz | 52 | 76 | - | 50 | 47 | |
| | 7GHz | 47 | 60 | - | 46 | 42 | |
| | 8GHz | 44 | 52 | - | 42 | 39 | |
| | 9GHz | 40 | 45 | - | 38 | 35 | |
| RF4 | 1GHz | 94 | 74 | 83 | - | 78 | dB |
| | 2GHz | 82 | 68 | 72 | - | 69 | |
| | 3GHz | 72 | 66 | 65 | - | 63 | |
| | 4GHz | 64 | 64 | 60 | - | 56 | |
| | 5GHz | 58 | 63 | 55 | - | 51 | |
| | 6GHz | 53 | 58 | 51 | - | 46 | |
| | 7GHz | 47 | 53 | 47 | - | 42 | |
| | 8GHz | 44 | 49 | 44 | - | 38 | |
| | 9GHz | 41 | 44 | 40 | - | 35 | |
| RF5 | 1GHz | 98 | 75 | 83 | 67 | - | dB |
| | 2GHz | 87 | 69 | 73 | 62 | - | |
| | 3GHz | 73 | 66 | 66 | 60 | - | |
| | 4GHz | 65 | 64 | 61 | 59 | - | |
| | 5GHz | 58 | 62 | 56 | 58 | - | |
| | 6GHz | 53 | 56 | 52 | 56 | - | |
| | 7GHz | 47 | 51 | 48 | 50 | - | |
| | 8GHz | 44 | 47 | 44 | 45 | - | |
| | 9GHz | 40 | 42 | 40 | 39 | - | |

Isolation Matrix

Typical conditions are Normal Mode¹(VDD = 5V, VSSEXT= 0V) or Bypass Mode²(VDD = 5V, VSSEXT = -3.5V), T_A = 25°C, Control Logic V1/V2/V3 Low = 0V, V1/V2/V3 High = 3.3V, Z_L = 50Ω, unless otherwise noted.

Table 3. RFx-to-RFx Isolation

| "ON" Port | Frequency | RFx to RFx Isolation | | | | | Unit |
|-----------|-----------|----------------------|-----|-----|-----|-----|------|
| | | RF1 | RF2 | RF3 | RF4 | RF5 | |
| RF1 | 1GHz | - | 67 | 87 | 74 | 69 | dB |
| | 2GHz | - | 61 | 75 | 70 | 64 | |
| | 3GHz | - | 58 | 67 | 68 | 62 | |
| | 4GHz | - | 56 | 61 | 68 | 61 | |
| | 5GHz | - | 55 | 56 | 69 | 62 | |
| | 6GHz | - | 54 | 52 | 60 | 61 | |
| | 7GHz | - | 53 | 47 | 52 | 52 | |
| | 8GHz | - | 49 | 43 | 46 | 46 | |
| | 9GHz | - | 46 | 39 | 42 | 40 | |
| RF2 | 1GHz | 68 | - | 78 | 73 | 68 | |
| | 2GHz | 63 | - | 67 | 68 | 63 | |
| | 3GHz | 61 | - | 59 | 66 | 61 | |
| | 4GHz | 62 | - | 54 | 66 | 60 | |
| | 5GHz | 65 | - | 49 | 68 | 61 | |
| | 6GHz | 56 | - | 46 | 60 | 62 | |
| | 7GHz | 49 | - | 42 | 53 | 53 | |
| | 8GHz | 43 | - | 38 | 47 | 46 | |
| | 9GHz | 39 | - | 35 | 42 | 41 | |
| RF3 | 1GHz | 73 | 77 | - | 67 | 67 | |
| | 2GHz | 68 | 66 | - | 62 | 62 | |
| | 3GHz | 67 | 59 | - | 60 | 60 | |
| | 4GHz | 70 | 54 | - | 60 | 59 | |
| | 5GHz | 80 | 49 | - | 59 | 62 | |
| | 6GHz | 61 | 46 | - | 54 | 62 | |
| | 7GHz | 53 | 42 | - | 48 | 52 | |
| | 8GHz | 47 | 39 | - | 43 | 46 | |
| | 9GHz | 42 | 35 | - | 39 | 40 | |
| RF4 | 1GHz | 74 | 85 | 67 | - | 64 | |
| | 2GHz | 70 | 74 | 62 | - | 59 | |
| | 3GHz | 70 | 66 | 59 | - | 57 | |
| | 4GHz | 75 | 61 | 57 | - | 58 | |
| | 5GHz | 74 | 56 | 56 | - | 64 | |
| | 6GHz | 60 | 52 | 54 | - | 58 | |
| | 7GHz | 52 | 47 | 51 | - | 48 | |
| | 8GHz | 46 | 43 | 47 | - | 42 | |
| | 9GHz | 42 | 39 | 42 | - | 37 | |
| RF5 | 1GHz | 76 | 86 | 74 | 82 | - | |
| | 2GHz | 72 | 75 | 68 | 69 | - | |
| | 3GHz | 71 | 68 | 65 | 60 | - | |
| | 4GHz | 79 | 62 | 62 | 54 | - | |
| | 5GHz | 70 | 57 | 60 | 49 | - | |
| | 6GHz | 59 | 53 | 57 | 45 | - | |
| | 7GHz | 52 | 48 | 53 | 41 | - | |
| | 8GHz | 45 | 44 | 48 | 37 | - | |
| | 9GHz | 41 | 40 | 44 | 34 | - | |

Product Description

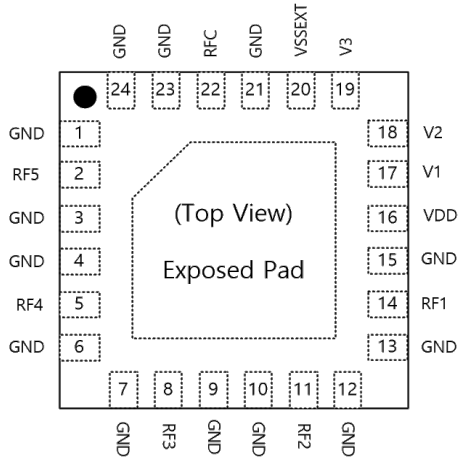

Figure 3. Pin Description

Table 4. Pin Descriptions

| No. | Pin Name | Descriptions |
|--|-------------|-------------------------------------|
| 16 | VDD | Supply Voltage |
| 20 | VSSEXT | Ground or External negative Voltage |
| 19 | V3 | Switch control input 3 |
| 18 | V2 | Switch control input 2 |
| 17 | V1 | Switch control input 1 |
| 2 | RF5 | RF5 Port |
| 5 | RF4 | RF4 Port |
| 8 | RF3 | RF3 Port |
| 11 | RF2 | RF2 Port |
| 14 | RF1 | RF1 Port |
| 22 | RFC | RFC Port |
| 1,3,4,6, 7,9,10,12, 13,15,21,23,24 | GND | Ground |
| Pad | Exposed Pad | Ground |

Table 5. Control Truth Table

| V3 | V2 | V1 | RFC-RF1 | RFC-RF2 | RFC-RF3 | RFC-RF4 | RFC-RF5 |
|----|----|----|------------------|------------------|------------------|------------------|------------------|
| 0 | 0 | 0 | OFF ¹ | OFF ¹ | OFF ¹ | OFF ¹ | OFF ¹ |
| 0 | 0 | 1 | ON | OFF | OFF | OFF | OFF |
| 0 | 1 | 0 | OFF | ON | OFF | OFF | OFF |
| 0 | 1 | 1 | OFF | OFF | ON | OFF | OFF |
| 1 | 0 | 0 | OFF | OFF | OFF | ON | OFF |
| 1 | 0 | 1 | OFF | OFF | OFF | OFF | ON |
| 1 | 1 | 0 | OFF ¹ | OFF ¹ | OFF ¹ | OFF ¹ | OFF ¹ |
| 1 | 1 | 1 | OFF ¹ | OFF ¹ | OFF ¹ | OFF ¹ | OFF ¹ |

1. Logic state 000, 110 and 111 are all path OFF mode.

Table 6. Recommended Operating Conditions

| | Parameter | Symbol | Min | Typ | Max | Unit |
|--|------------------------------|--------|------|------|------|------|
| Normal Mode ¹ | Supply Voltage | VDD | 2.7 | 5 | 5.5 | V |
| | Supply Current | IDD | - | 200 | - | μA |
| Bypass Mode ² | Supply Voltage | VDD | 2.7 | 5 | 5.5 | V |
| | Supply Current | IDD | - | 160 | - | μA |
| | Negative Supply Voltage | VSSEXT | - | -3.5 | -3.2 | V |
| Digital Input Voltage (V1/V2/V3) | V _{IH} | | 1.17 | - | 3.6 | V |
| | V _{IL} | | 0 | - | 0.6 | V |
| Digital Input Current (V1/V2/V3) | I _{CTRL} | | - | - | 10 | uA |
| Operating Temperature Range | T _{OP} | | -40 | +25 | +125 | °C |
| RF Input Power, CW (Active Port, +25°C) | P _{Max,Act,+25°C} | | - | - | 31 | dBm |
| RF Input Power, CW (Active Port, +125°C) | P _{Max,Act,+125°C} | | - | - | 31 | dBm |
| RF Input Power, CW (Terminated Port, +25°C) | P _{Max,Term,+25°C} | | - | - | 27 | dBm |
| RF Input Power, CW (Terminated Port, +125°C) | P _{Max,Term,+125°C} | | - | - | 24 | dBm |

* Specifications are not guaranteed over all recommended operating conditions.

1. Normal Mode : Single external positive supply voltage(VDD) is inputted.

2. Bypass Mode : Both external positive supply voltage(VDD) and external negative voltage(VSSEXT) are inputted.

Table 7. Absolute Maximum Ratings

| Parameter | | Symbol | Min | Max | Unit | |
|----------------------------------|-----|-----------------------------|---------------------|------|------|---|
| Supply Voltage | | VDD | -0.3 | 5.5 | V | |
| Digital Input Voltage | | V1/V2/V3 | -0.3 | 3.6 | V | |
| Maximum Input Power, CW (+25°C) | | P _{Max,Abs,+25°C} | - | 35 | dBm | |
| Maximum Input Power, CW (+125°C) | | P _{Max,Abs,+125°C} | - | 33 | dBm | |
| Storage Temperature range | | T _{ST} | -65 | +150 | °C | |
| ESD | HBM | All pins | V _{ESDHBM} | - | 1000 | V |
| | CDM | All pins | V _{ESDCDM} | - | 1000 | V |

1. HBM Standard : JEDEC Standard JS-001-2017

2. CDM Standard : JEDEC Standard JS-002-2018

Typical Performances

Typical conditions are Normal mode, VDD = 5V, T_A = 25°C, V1/V2/V3 Low = 0V, V1/V2/V3 High = 3.3V, Z_L = 50Ω, PCB and RF Connector loss are de-embedded, unless otherwise noted.

Figure 4. Insertion Loss vs Frequency

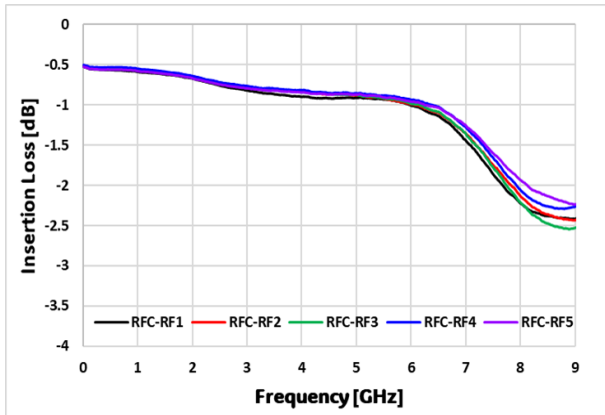

Figure 5. Insertion Loss vs VDD (RFC-RF1)

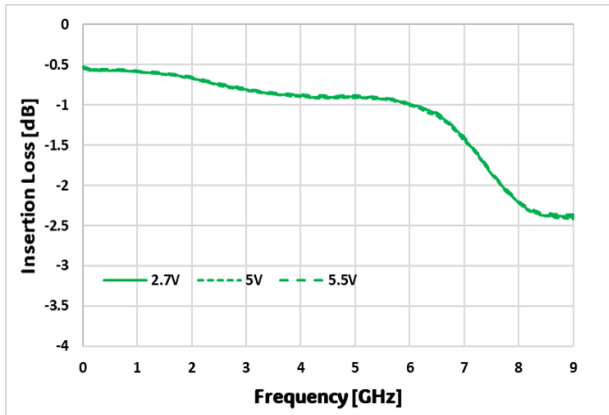

Figure 6. Insertion Loss vs Temp (RFC-RF1)

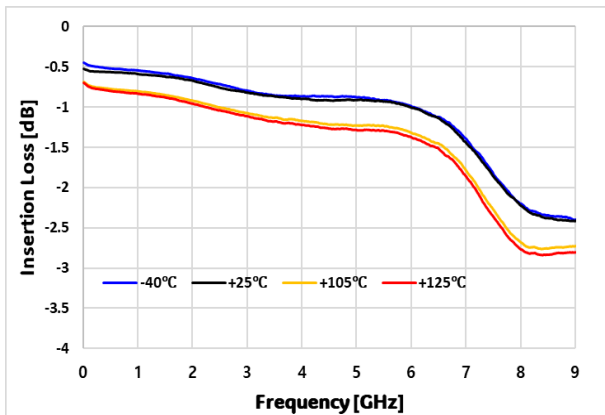

Figure 7. Return Loss vs Frequency (RFC Port)

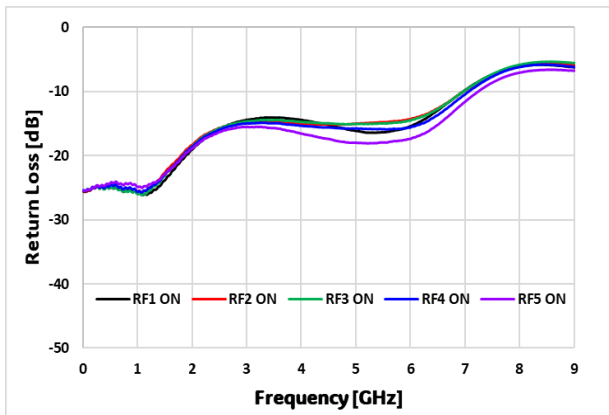

Figure 8. Return Loss vs VDD (RFC Port)

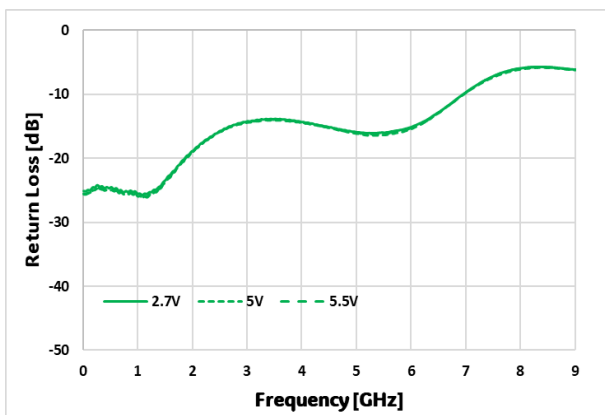
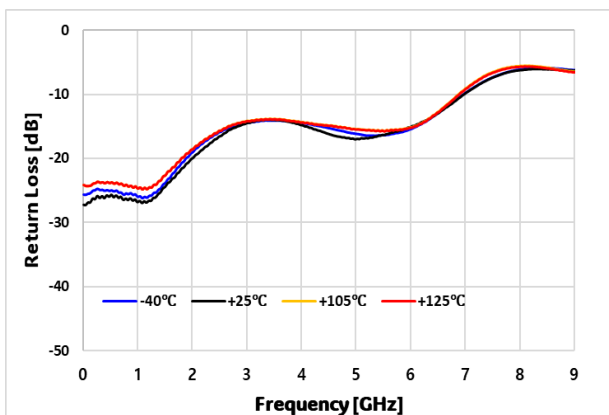

Figure 9. Return Loss vs Temp (RFC Port)



Typical Performances

Typical conditions are Normal mode, VDD = 5V, T_A = 25°C, V1/V2/V3 Low = 0V, V1/V2/V3 High = 3.3V, Z_L = 50Ω, PCB and RF Connector loss are de-embedded, unless otherwise noted.

Figure 10. Return Loss vs Frequency (Active Port)

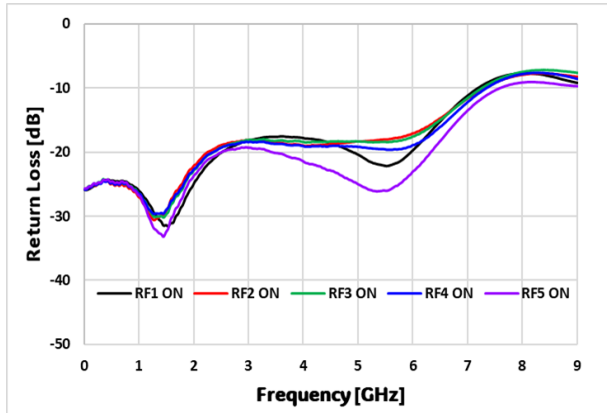

Figure 11. Return Loss vs VDD (Active Port)

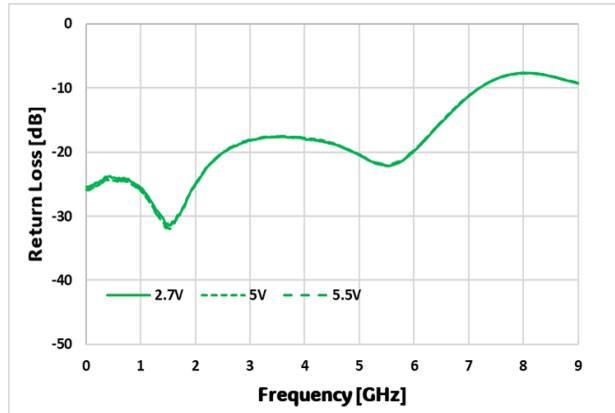

Figure 12. Return Loss vs Temp (Active Port)

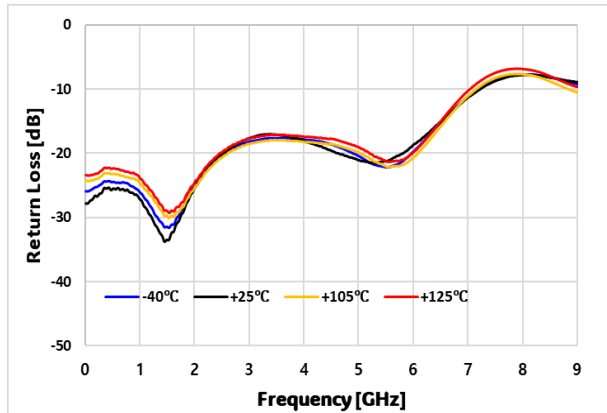

Figure 13. Return Loss vs Frequency (Terminated Port)

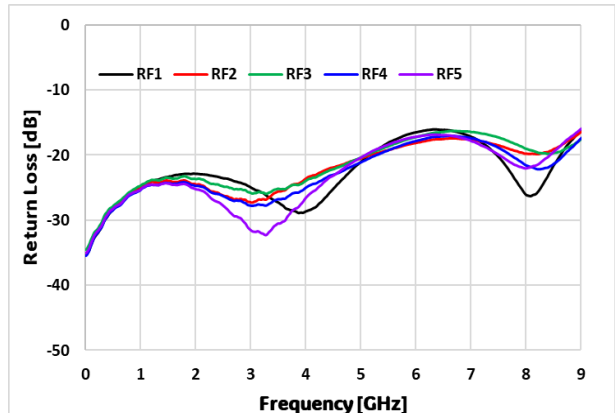

Figure 14. Return Loss vs VDD (Terminated Port)

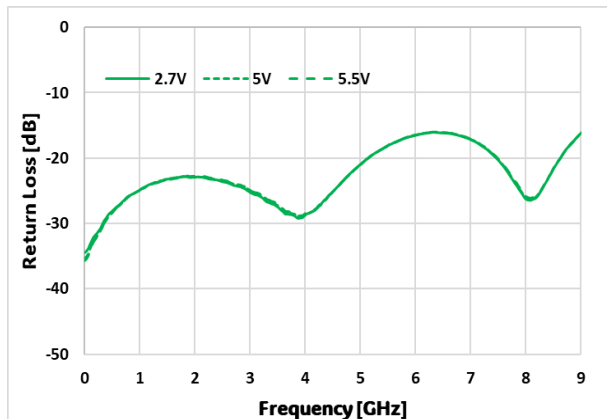
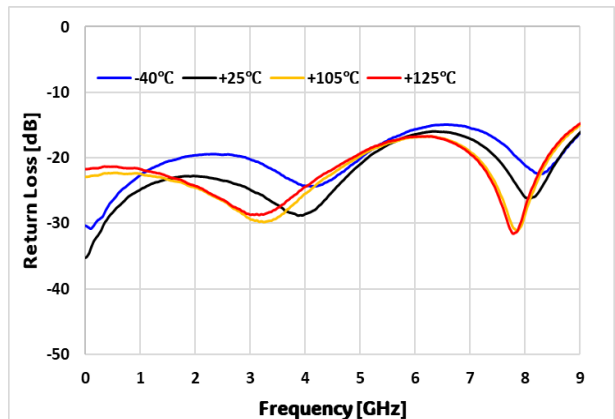

Figure 15. Return Loss vs Temp (Terminated Port)



Typical Performances

Typical conditions are Normal mode, VDD = 5V, T_A = 25°C, V1/V2/V3 Low = 0V, V1/V2/V3 High = 3.3V, Z_L = 50Ω, PCB and RF Connector loss are de-embedded, unless otherwise noted.

Figure 16. Isolation vs Frequency (RFC to RFx)

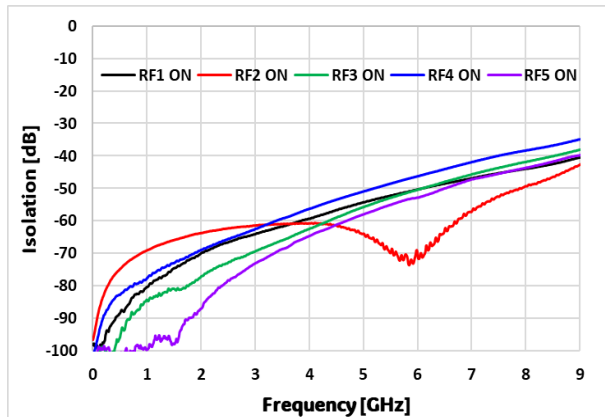

Figure 17. Isolation vs Frequency (RFC to RFx, RF1 ON)

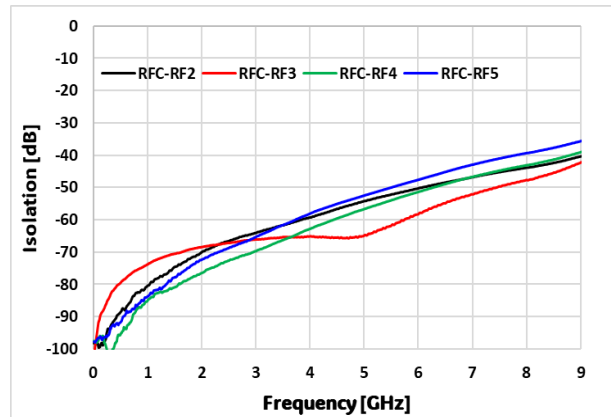

Figure 18. Isolation vs VDD (RFC to RF1, RF2 ON)

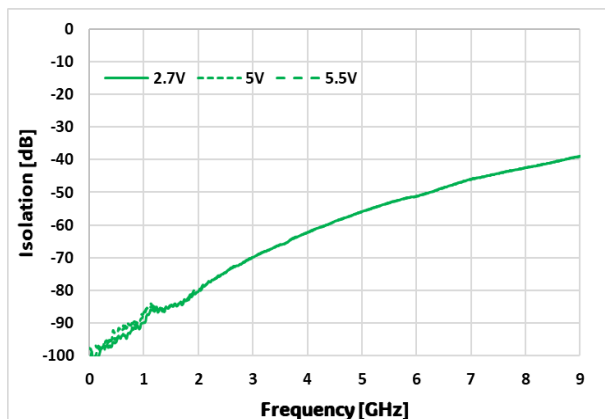

Figure 19. Isolation vs Temp (RFC to RF3, RF1 ON)

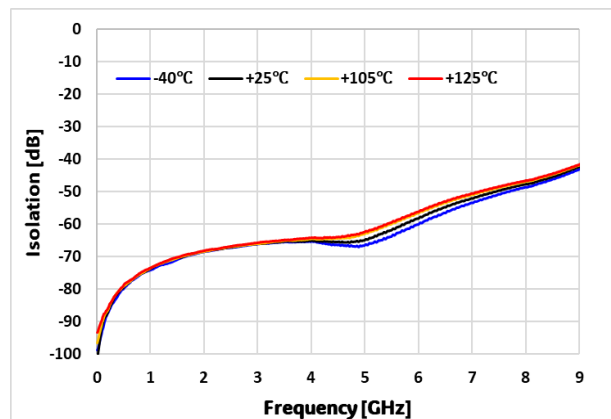

Figure 20. Isolation vs Frequency (RFx to RFx)

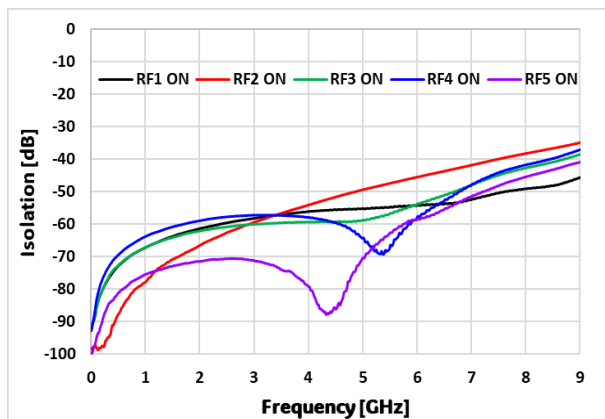
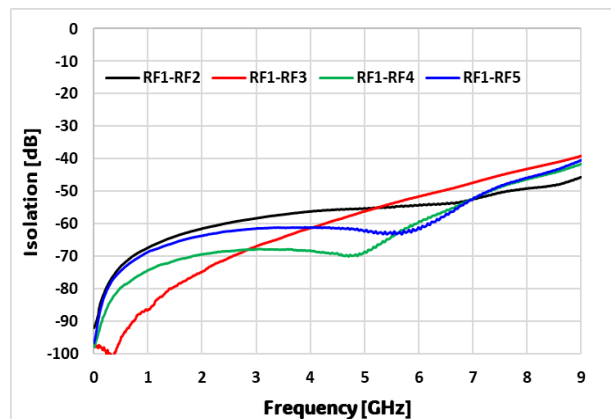

Figure 21. Isolation vs Frequency (RF1 to RFx, RF1 ON)



Typical Performances

Typical conditions are Normal mode, VDD = 5V, T_A = 25°C, V1/V2/V3 Low = 0V, V1/V2/V3 High = 3.3V, Z_L = 50Ω, PCB and RF Connector loss are de-embedded, unless otherwise noted.

Figure 22. Isolation vs VDD (RF1 to RF2, RF1 ON)

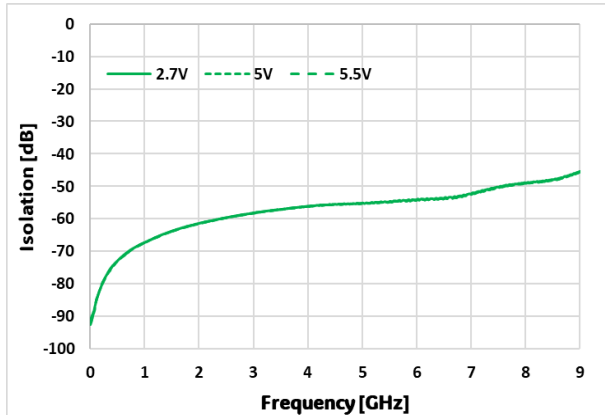

Figure 23. Isolation vs Temp (RF1 to RF2, RF1 ON)

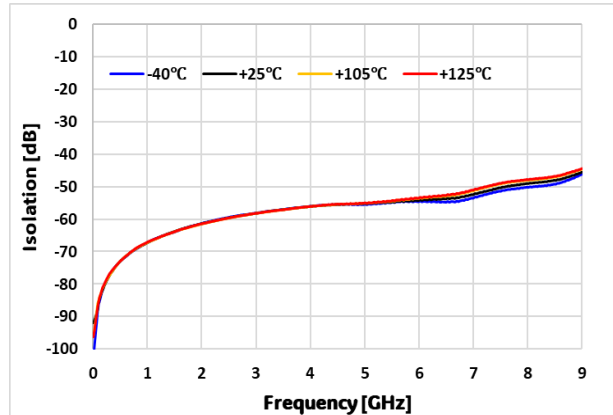

Figure 24. IIP3 vs RF Port

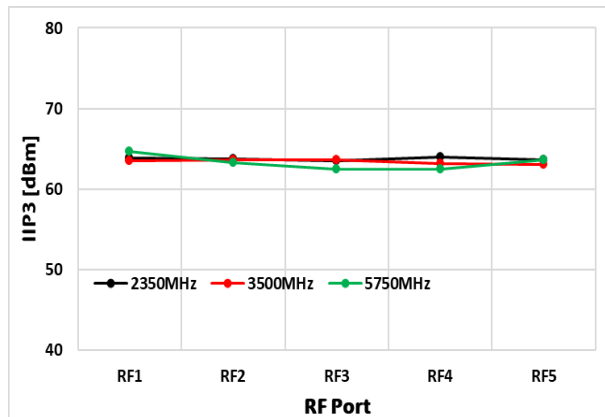
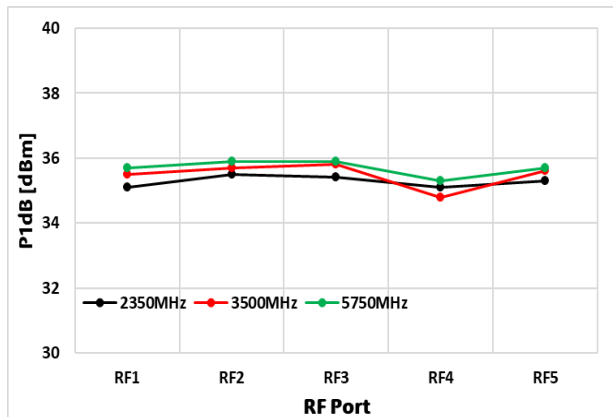

Figure 25. P1dB vs RF Port



Evaluation Board

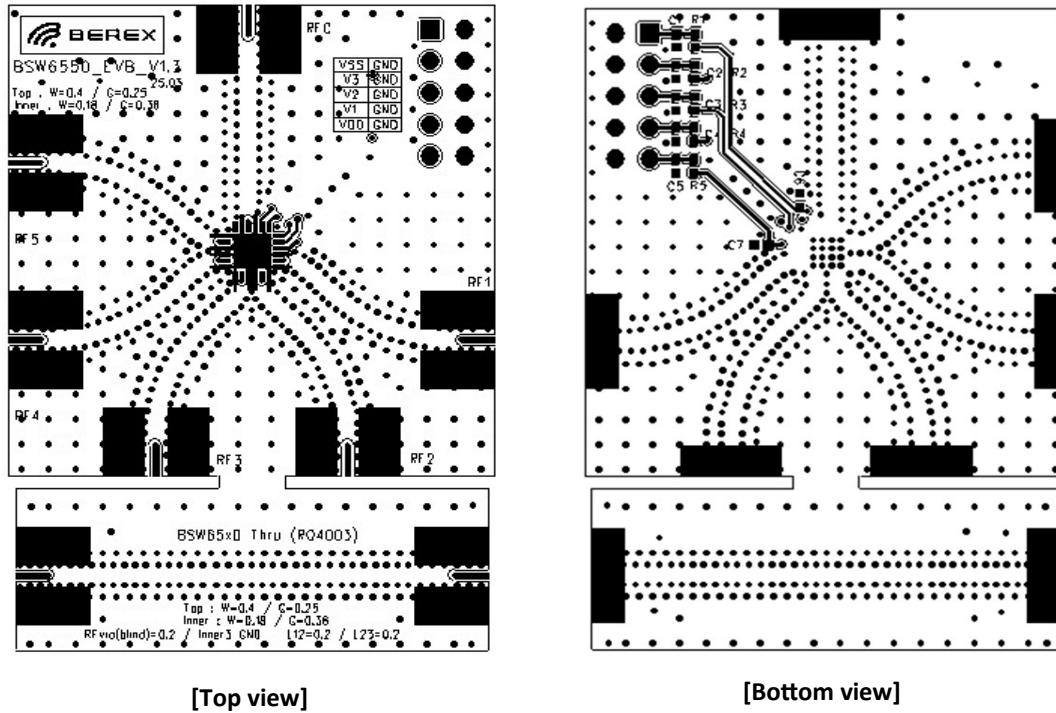

Figure 26. Evaluation Board Layout

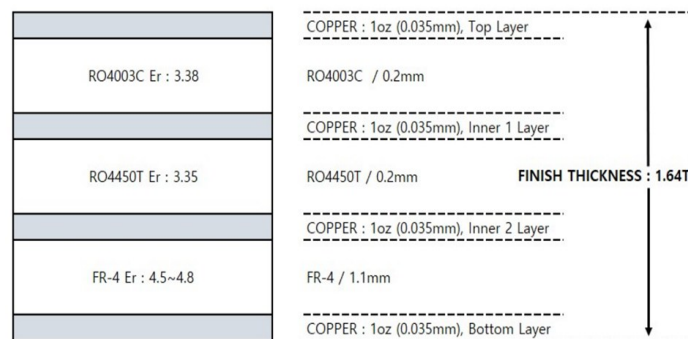

Figure 27. Evaluation Board PCB Layer Information

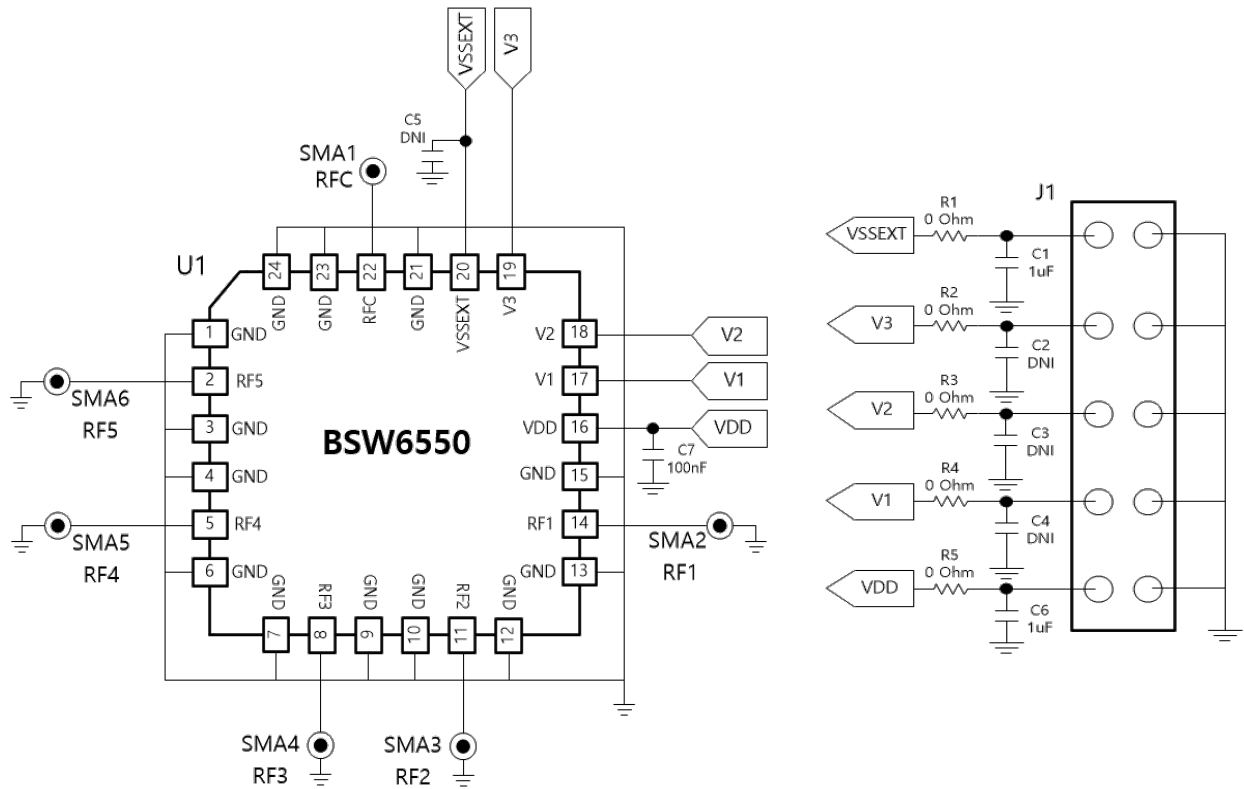
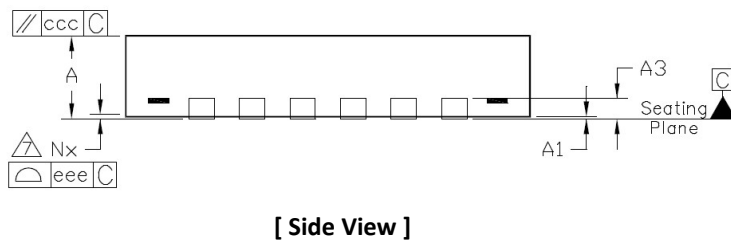
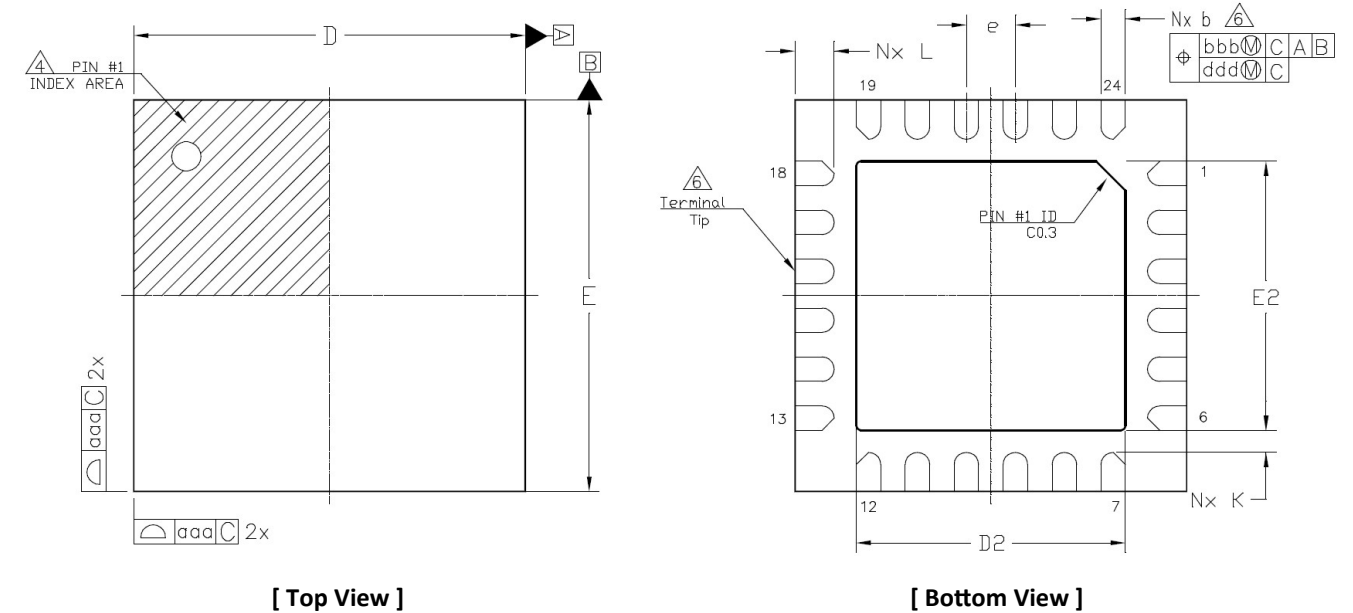

Figure 28. Evaluation Board Schematic

Table 8. Bill of Material - Evaluation Board

| No. | Ref Des | Part Qty | Value | Description | Remark |
|-----|-------------------------|----------|--------|----------------|--------|
| 1 | C1,C6 | 2 | 1uF | CAP 1005 J 50V | |
| 2 | C7 | 1 | 100nF | CAP 1005 J 50V | |
| 3 | C2,C3,C4,C5 | 4 | DNI | CAP 1005 | |
| 4 | R1,R2,R3,R4,R5 | 5 | 0 ohm | RES 1005 J 50V | |
| 5 | J1 | 1 | 2.54mm | 2x5 pin Header | |
| 6 | RFC,RF1,RF2,RF3,RF4,RF5 | 6 | CON | SMA_END_LAUNCH | |
| 7 | U1 | 1 | Chip | BSW6550 | |

Package Outline Drawing

NOTES:

1. Dimensioning and tolerancing conform to ASME Y14.5–2009.
2. All dimensions are in millimeters.
3. N is the total number of terminals.
4. The location of the marked terminal #1 identifier is within the hatched area.
5. ND and NE refer to the number of terminals each D and E side respectively.
6. Dimension b applies to the metallized terminal and is measured between 0.15mm and 0.3mm from the terminal tip. If the terminal has a radius on the other end of it, dimension b should not be measured in that radius area.
7. Coplanarity applies to the terminals and all other bottom surface metallization.

| Dimension Table (Notes 1,2) | | | | | |
|-----------------------------|-----------|----------|------------|------|------|
| Symbol | Thickness | Min | Nominal | Max | Note |
| A | | 0.70 | 0.75 | 0.80 | |
| A1 | | 0.00 | 0.02 | 0.05 | |
| A3 | | --- | 0.203 Ref. | --- | 6 |
| b | | 0.20 | 0.25 | 0.30 | |
| D | | 4.00 BSC | | | |
| E | | 4.00 BSC | | | |
| e | | 0.50 BSC | | | |
| D/2 | | 2.65 | 2.70 | 2.75 | |
| E/2 | | 2.65 | 2.70 | 2.75 | |
| K | | 0.2 | --- | --- | |
| L | | 0.30 | 0.40 | 0.50 | |
| aaa | | 0.05 | | | |
| bbb | | 0.10 | | | |
| ccc | | 0.10 | | | |
| ddd | | 0.05 | | | |
| eee | | 0.08 | | | |
| N | | 24 | | | 3 |
| ND | | 6 | | | 5 |
| NE | | 6 | | | 5 |

Figure 29. Package Outline Drawing

Recommended Land Pattern

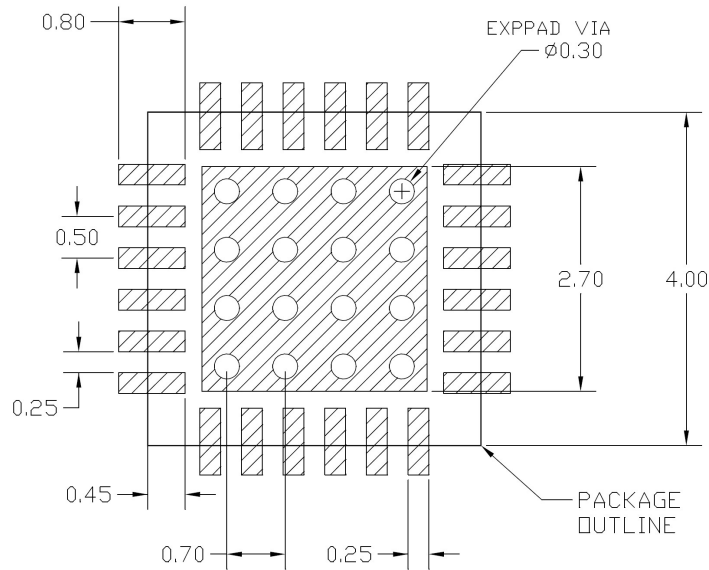

Figure 30. Recommended Land Pattern

Package Marking



| Marking information: | |
|----------------------|--------------------|
| BSW | BeRex RF Switch |
| 6550 | The name of switch |
| YY | Year |
| WW | Work Week |
| XX | Wafer Run Number |

Figure 31. Package Marking

Tape & Reel (TBD)

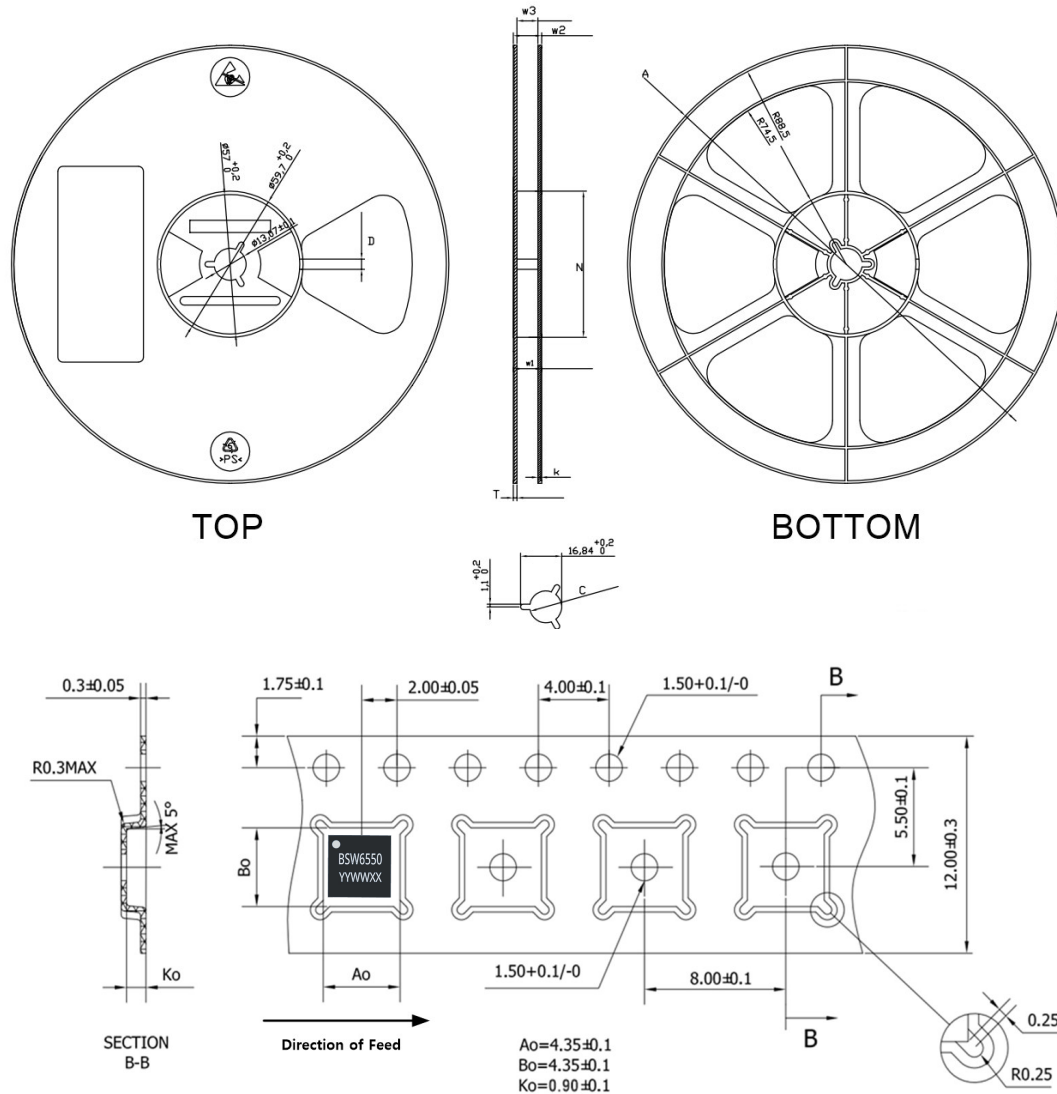

NOTES:
 1 10 SPROCKET HOLE PITCH CUMULATIVE TOLERANCE #0.2
 2 CAMBER IN COMPLIANCE WITH EIA 481
 3 POCKET POSITION RELATIVE TO SPROCKET HOLE MEASURED AS TRUE POSITION OF POCKET, NOT POCKET HOLE

| Packaging information: | |
|------------------------|--------|
| Tape Width | 12mm |
| Reel Size | 7inch |
| Device Cavity Pitch | 8mm |
| Device Per Reel | 1000EA |

Figure 32. Tape & Reel

Lead plating finish

100% Tin Matte finish

(All BeRex products undergo a 1 hour, 150°C, anneal bake to eliminate thin whisker growth concerns.)

ESD / MSL Rating

| ESD information1 : | |
|--------------------|----------------------------|
| Rating | Class 1C (1000V) |
| Test | Human Body Model (HBM) |
| Standard | JEDEC Standard JS-001-2017 |

| ESD information2 : | |
|--------------------|----------------------------|
| Rating | Class C3 (1000V) |
| Test | Charged Device Model (CDM) |
| Standard | JEDEC Standard JS-002-2018 |

| MSL information: | |
|------------------|-------------------------------------|
| Rating | Level 1 at +260°C convection reflow |
| Standard | JEDEC Standard J-STD-020 |



Proper ESD procedures should be followed when handling the device.

RoHS Compliance

This part is compliant with Restrictions on the use of certain Hazardous Substances in Electrical and Electronic Equipment (RoHS) Directive 2011/65/EU as amended by Directive 2015/863/EU.

This product also is compliant with a concentration of the Substances of Very High Concern (SVHC) candidate list which are contained in a quantity of less than 0.1%(w/w) in each components of a product and/or its packaging placed on the European Community market by the BeRex and Suppliers.

NATO CAGE code:

| | | | | |
|---|---|---|---|---|
| 2 | N | 9 | 6 | F |
|---|---|---|---|---|